

BVH & BVAH 7500/6000 PSI

The benchmark of quality and value ~ Made in U.S.A.

Widest array of sizes, connections and accessories



- Steel construction rated up to 7500 PSI for continuous/normal operation. **Stainless Steel available in all sizes but rated at 7500 PSI for ¼" through ½", 6000 ¾" and 3000 PSI for 1" and up. (see BVHS for 6000 PSI)**
- DMIC's **BVH** Block Body & **BVAH** Round Body offered in largest range of ball orifice diameters. (¼"-6") - S.S BVH ¾" - 1" are round body design
- Unrestricted bore offered, Steel Balls, for minimal system pressure drop
- Widest array of connection types available
- Standard Delrin™ Ball Seals & Buna-N Elastomer Seals. Other materials available, for full fluid compatibility range. Standard Black Oxide finish on all Steel Valves. Other finishes are available upon request.
- Temperature Range: -60°F to 400°F (Depending on material combinations)
- Extensive variety of additional accessories available
- Fast delivery on any valve contained in this series

*Please note: For valves larger than 2", large pressure differentials may make the valve difficult to open and the pressure balance option may be required. Ask your DMIC sales Associate for more info!

Service Parts BOM

BVH/ BVAH	SERVICE PARTS BOM	
Index	Qty	Description
1	1	Valve Body
2	1	Ball
3	1	Spindle
4	2	Ball Seal
5	1*	End Connection(s)
6	1*	End Connection O-Ring(s)
7	1	Internal Thrust Washer
8	1	Spindle O-Ring(s)
9	1	External Glide Washer
10	1	Stop Pin
11	1	Stop Washer
12	1	Color Code Cap
13	1	Handle Screw
14	1	Handle

*Quantity depends on size and configuration

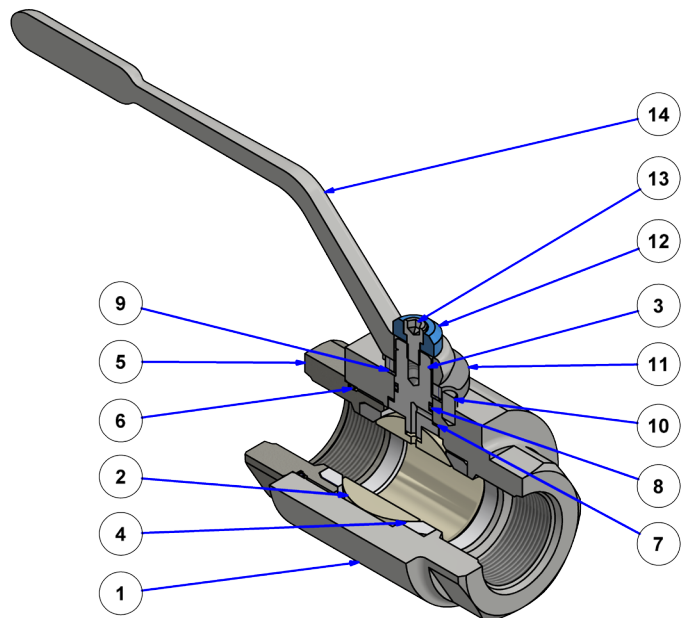

BVH & BVAH 7500/6000 PSI

Ordering Codes Summary

Please see the expanded section on Construction Materials and DMIC Pre-Engineered Accessories, pgs 12-15

See page 14 for accessory codes

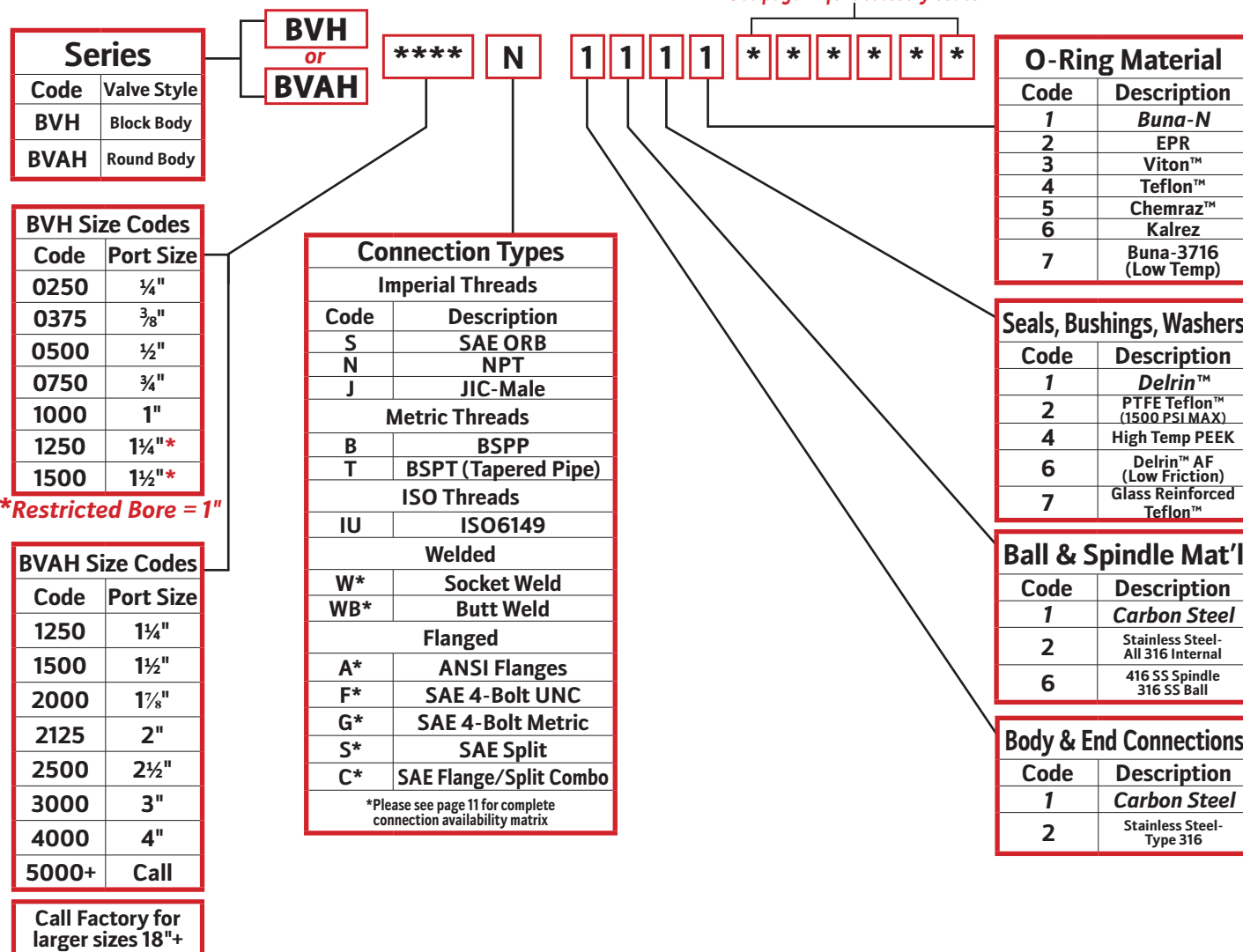

Note: Changes from Standard Materials may result in changes to temperature and/or pressure rating. Due to our policy of continual product improvement, the specifications in this catalog may change without notice. When designing by spec, please request a certified print.



BVH & BVAH 7500/6000 PSI

BVH/ BVAH		Dimensions (1 of 2)									
<i>Dimensions B, C, D, E, F, G, & H are common dimensions shared between all BVH and BVAH Valves, independent of Connection Type</i>											
Threaded Connections											
Dimension (Inches)		-	A	B	C	D	E	F	G	H	
Port Code(s)	Port Size	Working PSI	Overall Length	Body Diameter / Width	Bore Size	Handle Length	Overall Height	Bottom to Port Center	Port Center to Top	Body Height	
N S B IU Threaded Connections	¼"	7500 PSI	2.74	1.38	0.31	4.50	2.99	0.61	1.55	1.38	
	⅜"		2.87	1.50	0.38	4.50	3.12	0.64	1.65	1.50	
	½"		3.36	1.63	0.50	4.50	3.25	0.73	1.69	1.63	
	¾"		3.79	2.25	0.75	7.00	4.72	1.00	2.29	2.25	
	1"		4.49	2.50	0.94	7.00	4.97	1.14	2.40	2.50	
	1¼"	5.24	2.50	0.94	7.00	4.97	1.14	2.40	2.50		
	1½"	5.47	2.50	0.94	7.00	4.97	1.14	2.40	2.50		
	1¾"	4.85	3.38	1.25	9.86	6.46	1.45	3.14	3.26		
	2"	5.33	3.75	1.50	9.86	6.84	1.64	3.33	3.64		
	2½"	6.54	4.50	1.88	9.86	7.50	2.01	3.62	4.30		
3"	6.54	5.00	2.00	9.86	8.05	2.38	3.80	4.85			
3½"	7.50	7.22	2.50	12.00	10.46	3.61	5.14	6.94			
4"	9.29	7.50	3.00	15.00	12.73	4.43	N/A	8.45			
4"	11.21	9.94	4.00	20.00	15.82	5.67	N/A	10.94			
*Denotes BVH 1" reduced ball with 1-¼" or 1-½" connections											
** Denotes Round Body Design for S.S.											
SAE C.61 4-Bolt Flange Connections											
Dimension (inches)		-	A	C	J	K	L	M			
Port Code(s)	Port Size	Working PSI	Overall Length FM/GM	Bore Size	Flange Diameter	Flg Pad Short	Flg Pad Long	UNC Bolt Thread	Metric Bolt Thread		
FM/GM SAE C.61 4-Bolt Comp Connections	½"	5000 PSI	4.26	0.50	2.13	0.69	1.50	5/16"	M8		
	¾"		4.77	0.75	2.75	0.88	1.88	3/8"	M10		
	1"		5.27	0.94	3.00	1.03	2.06	3/8"	M10		
	1¼"	4000 PSI	6.90	1.25	3.38	1.19	2.31	7/16"	M10		
	1½"		7.09	1.50	3.75	1.41	3.13	½"	M12		
	2"	3000 PSI	8.06	1.88	4.50	1.69	3.06	½"	M12		
	2½"		8.06	2.00	4.50	1.69	3.06	½"	M12		
	2½"		2500 PSI	11.25	2.50	5.00	2.00	3.50	½"	M12	
	3"	2000 PSI	13.65	3.00	6.00	2.44	4.19	5/8"	M16		
	4"	500 PSI	16.22	4.00	8.50	3.06	5.13	5/8"	M16		
SAE C.62 4-Bolt Flange Connections (6,000 PSI)											
Dimension (inches)		-	A	C	J	K	L	M			
Port Code(s)	Port Size	Working PSI	Overall Length	Bore Size	Flange Diameter	Flg Pad Short	Flg Pad Long	UNC Bolt Thr	Metric Bolt Thr		
FH/GH SAE C.62 4-Bolt Comp Connections	½"	5000 PSI	4.26	0.50	2.25	0.72	1.59	5/16"	M8		
	¾"		4.77	0.75	2.75	0.94	2.00	3/8"	M10		
	1"		5.27	0.94	3.38	1.09	2.25	7/16"	M10		
	1¼"	4000 PSI	6.90	1.25	3.75	1.25	2.63	½"	M12		
	1½"		7.09	1.50	4.50	1.44	3.13	5/8"	M16		
	2"	3000 PSI	8.06	1.88	5.50	1.75	3.81	3/4"	M20		
	2½"		8.06	2.00	5.50	1.75	3.81	3/4"	M20		
	2½"		2500 PSI	13.88	2.50	2-232	FSL-2500SK	12.56			
	3"	2000 PSI	15.65	3.00	2-237	FSL-3000SK	14.65				
	4"	500 PSI	18.09	4.00	2-245	FSL-4000SK	17.15				
Call Factory											
SAE C.61 Split Flange Connections											
Dimension (inches)		-	A	C	N	-		A			
Port Code(s)	Port Size	Working PSI	Overall Length (SM)	Bore Size	O-Ring No.	DMIC Split Flange Kit		Overall Length (CM)			
SM/CM SAE C.61 Split & Combo	½"	5000 PSI	5.96	0.50	2-210	FSL-0500SK		5.11			
	¾"		6.38	0.75	2-214	FSL-0750SK		5.58			
	1"		6.99	0.94	2-219	FSL-1000SK		6.13			
	1¼"	4000 PSI	7.50	1.25	2-222	FSL-1250SK		7.20			
	1½"		9.09	1.50	2-225	FSL-1500SK		8.09			
	2"	3000 PSI	9.10	1.88	2-228	FSL-2000SK		8.58			
	2½"		9.10	2.00	2-228	FSL-2000SK		8.58			
	2½"		2500 PSI	13.88	2.50	2-232	FSL-2500SK		12.56		
	3"	2000 PSI	15.65	3.00	2-237	FSL-3000SK		14.65			
	4"	500 PSI	18.09	4.00	2-245	FSL-4000SK		17.15			
SAE C.62 Split Flange Connections (6000 PSI)											
Dimension (inches)		-	A	C	N	-		A			
Port Code(s)	Port Size	Working PSI	Overall Length (SH)	Bore Size	O-Ring No.	DMIC Split Flange Kit		Overall Length (CH)			
SH/CH SAE C.62 Split & Combo	½"	5000 PSI	5.96	0.50	2-210	FSH-0500SK		5.11			
	¾"		6.86	0.75	2-214	FSH-0750SK		5.82			
	1"		7.79	0.94	2-219	FSH-1000SK		6.53			
	1¼"	4000 PSI	8.77	1.25	2-222	FSH-1250SK		7.83			
	1½"		11.07	1.50	2-225	FSH-1500SK		9.08			
	2"	3000 PSI	12.44	1.88	2-228	FSH-2000SK		10.25			
	2½"		12.44	2.00	2-228	FSH-2000SK		10.25			

All BVH C.S

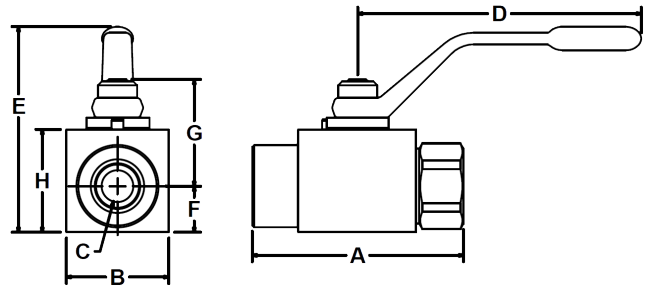

N, S, B, IU THREADED CONNECTIONS
For All BVH & 3/8" - 1" BVH S.S

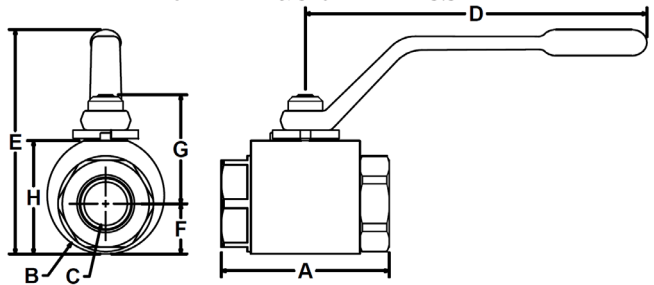

FM/FH, GM/GH SAE 4-Bolt Flange (COMP)

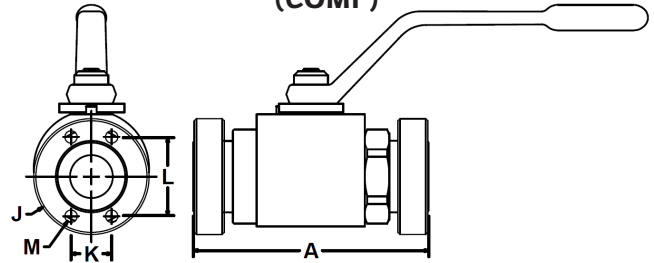

SM/SH SAE SPLIT-FLANGE HEAD

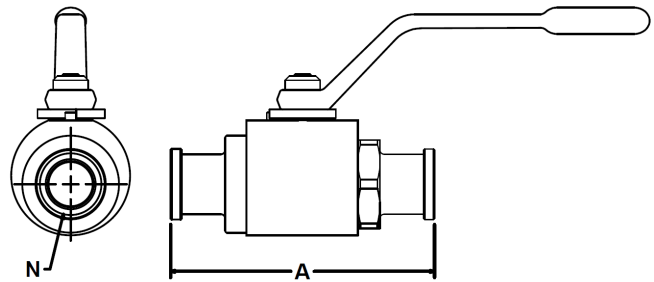

CM/CH SAE 4_BOLT & SPLIT "COMBO" FLANGE

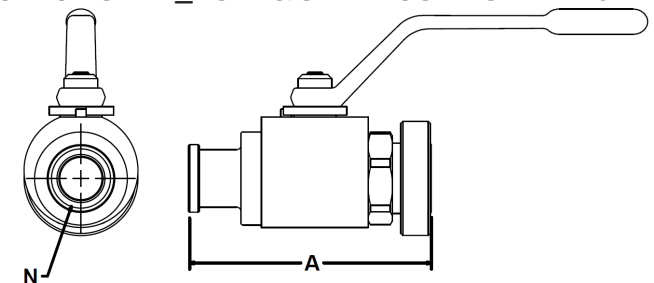

BVH & BVAH 7500/6000 PSI

BVH/ BVAH	Dimensions (2 of 2)					
Fixed Socket Weld Connections (6000 PSI)						
Dimension (Inches)	A	C	P	Q	R	
Port Code(s)	Port Size	Overall Length	Bore Size (Ball)	Socket Depth	Connection Inside Diameter	Inside Socket Outer Diameter
W* *4-SCH 40 *8-SCH 80 *F-SCH 160 *G-XXS More Sizes Available Upon Request	½"	6.26	0.50	0.75	Based Upon Pipe Schedule	0.88
	¾"	7.46	0.75	0.75		1.09
	1"	7.67	0.94	1.00		1.36
	1½"	8.40	1.25	1.00		1.69
	2"	9.47	1.50	1.00		1.95
	2½"	10.60	1.88	1.00		2.44
	3"	10.60	2.00	1.00		2.44
<i>Call Factory</i>						
Fixed Butt-Weld Connections (6000 PSI)						
Dimension (Inches)	A	C	T	Q		
Port Code(s)	Port Size	Overall Length	Bore Size (Ball)	Weld Neck Outside Diameter	Connection Inside Diameter	
WB* *4-SCH 40 *8-SCH 80 *F-SCH 160 *G-XXS More Sizes Available Upon Request	½"	4.26	0.50	0.84	Based Upon Pipe Schedule	
	¾"	6.35	0.75	1.06		
	1"	7.67	0.94	1.31		
	1½"	8.35	1.25	1.66		
	2"	9.47	1.50	1.91		
	2½"	10.60	1.88	2.38		
	3"	10.60	2.00	2.38		
<i>Call Factory</i>						

W(*) FIXED SOCKET WELD
(* PIPE SCHEDULE CHARACTER)

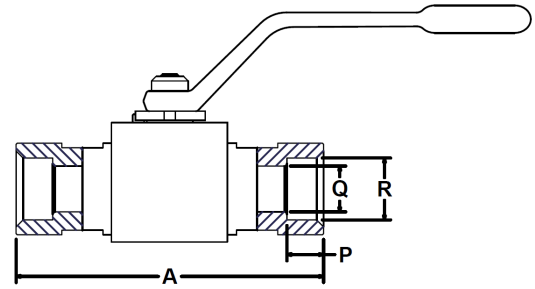

WB(*) FIXED BUTT WELD
(* PIPE SCHEDULE CHARACTER)

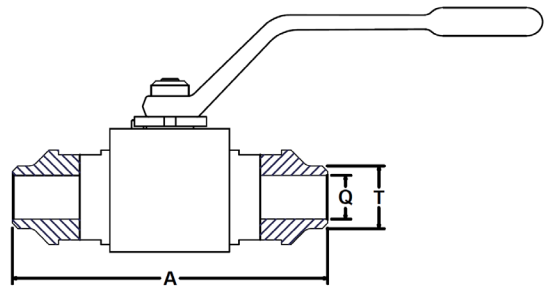

***Please Note:**
Always operate System Pressure according to Pipe Schedule

Flow Characteristic and Actuation Torque Curves

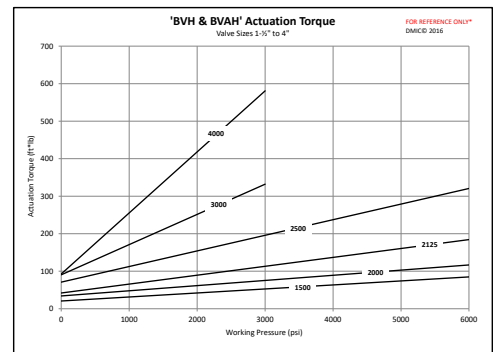
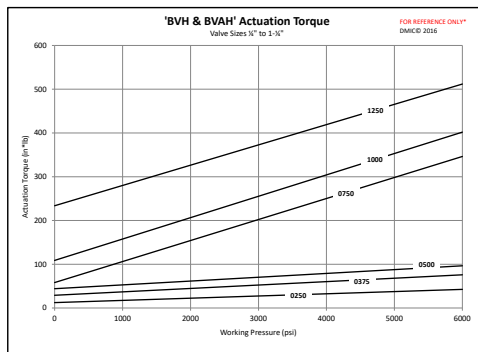
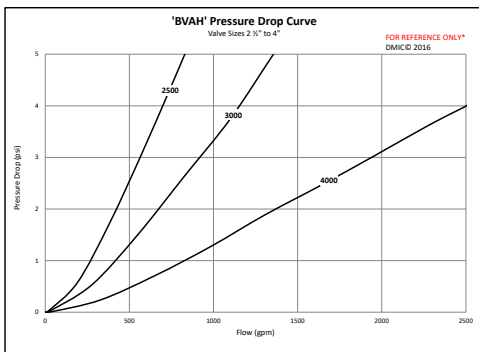
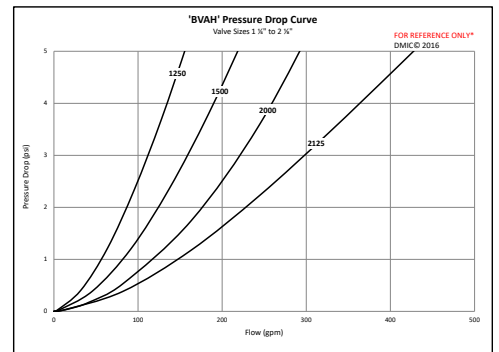
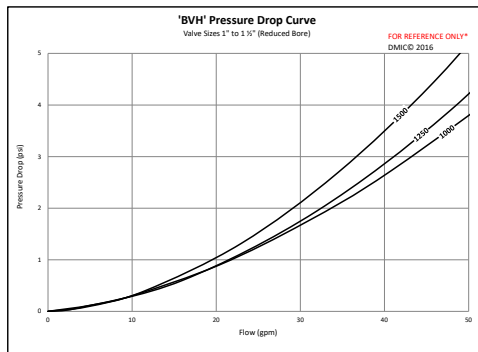
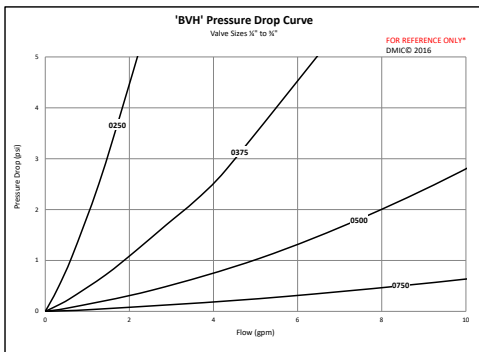

Due to our policy of continual product improvement, the specifications in this catalog may change without notice. When designing by spec, please request a certified print.

