

Return Filters**E 441 · E 451 · E 461 · E 641 · E 700**

Tank mounting · Nominal flow rate up to 800 l/min / 211.4 gpm



Return Filter E 461

Description**Application**

In the return line circuits of hydraulic systems.

Performance features*Protection against wear:*

By means of filter elements that even in full-flow filtration meet the highest demands regarding cleanliness classes.

Protection against malfunction:

By means of full-flow filtration in the system return, the pumps above all are protected from dirt particles remaining in the system after assembly, repairs, or which are generated by wear or enter the system from outside.

Special features

- › Installation:
Installation directly into a separate tank section for the return oil. This solution allows a number of return line connections and does not show any restriction by a filter head.
- › By-pass valve:
The location close to the inlet port prevents dirt particles retained by the filter element from entering into the clean oil side.
- › Removable bowl:
In case of maintenance the filter bowl is removed together with the filter element - therefore dirt particles are not flushed back into the tank.

Filter elements

Flow direction from outside to center.

The star-shaped pleating of the filter material results in:

- › large filter surfaces
- › high dirt-holding capacities
- › low pressure drop
- › long service life

Filter maintenance

By using a clogging indicator the correct moment for maintenance is stated and guarantees the optimum utilization of the filter life.

Materials

Filter bowl:	Steel, phosphated
Housing bottom: (for E 700:	Polyamide, GF reinforced Steel, phosphated)
Seals:	NBR (FPM on request)
Filter media:	EXAPOR®MAX2 - inorganic multi-layer microfiber web Paper - cellulose web, impregnated with resin

Accessories

Extension pipes or diffusers on the bowl outlet are available on request. Even the combination of both options is possible.

Extension pipe:

A correct extension pipe length ensures oil outlet below minimum oil level and prevents foaming.

Diffusers:

Diffusers reduce oil velocity and direct the oil to 90° outlet flow. This function prevents also oil foaming and whirling up of solid particles settled at the tank bottom.

Electrical and optical clogging indicators are available on request. Dimensions and technical data see catalog sheet 60.20.

Characteristics

Nominal flow rate

Up to 800 l/min / 211.4 gpm (see Selection Chart, column 2). The nominal flow rates indicated by ARGO-HYTOS are based on the following features:

- › closed by-pass valve at $v \leq 200 \text{ mm}^2/\text{s} / 927 \text{ SUS}$
- › element service life > 1000 operating hours at an average fluid contamination of 0.07 g per l/min / 0.27 g per gpm flow volume
- › flow velocity in the connection lines $\leq 4.5 \text{ m/s} / 14.8 \text{ ft/s}$

Installation

Tank immersed installation in a separate return oil chamber of the reservoir.

Filter fineness

10 $\mu\text{m(c)}$... 30 $\mu\text{m(c)}$
 β -values according to ISO 16889
(see Selection Chart, column 4 and diagram Dx)

Dirt-holding capacity

Values in g test dust ISO MTD according to ISO 16889
(see Selection Chart, column 5).

Hydraulic fluids

Mineral oil and biodegradable fluids
(HEES and HETG, see info-sheet 00.20).

Temperature range

-30 °C ... +100 °C (temporary -40 °C ... +120 °C)
-22 °F ... +100 °F (temporary -40 °F ... +248 °F)

Viscosity at nominal flow rate

- › at operating temperature: $v < 60 \text{ mm}^2/\text{s} / 280 \text{ SUS}$
- › as starting viscosity: $v_{\text{max}} = 1200 \text{ mm}^2/\text{s} / 5560 \text{ SUS}$
- › at initial operation:
The recommended starting viscosity can be read from the diagram D (pressure drop as a function of the kinematic viscosity) as follows: Find the 70% Δp of the cracking pressure of the by-pass valve on the vertical axis. Draw a horizontal line so that it intersects the Δp curve at a point. Read this point on the horizontal axis for the viscosity.

Operating pressure

Max. 10 bar / 145 psi

Mounting position

Preferably vertical, outlet downwards.

Δp-curves for complete filters in Selection Chart, column 3

D1 Pressure drop as a function of the **flow volume**
at $v = 35 \text{ mm}^2/\text{s} / 162 \text{ SUS}$ (0 = casing empty)

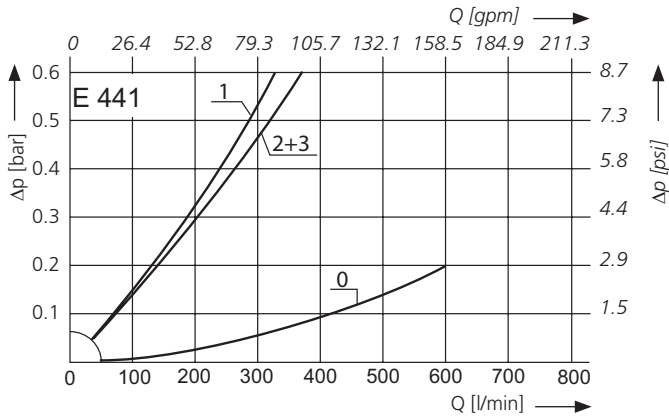

Pressure drop as a function of the **kinematic viscosity** at nominal flow

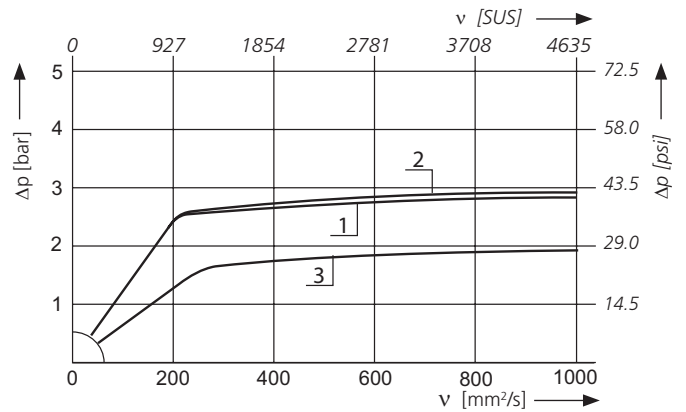

D2 Pressure drop as a function of the **flow volume**
at $v = 35 \text{ mm}^2/\text{s} / 162 \text{ SUS}$ (0 = casing empty)

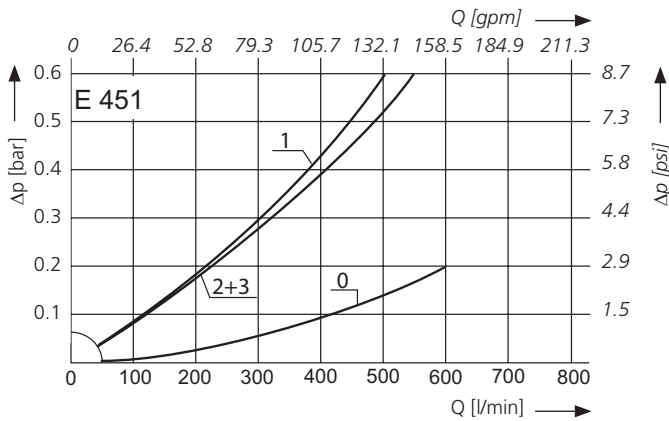

Pressure drop as a function of the **kinematic viscosity** at nominal flow

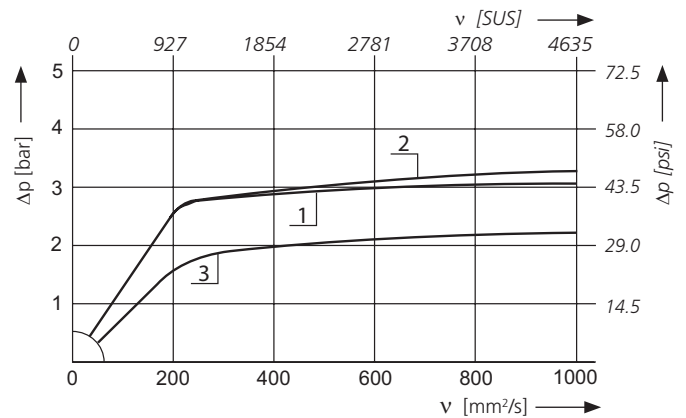

D3 Pressure drop as a function of the **flow volume**
at $v = 35 \text{ mm}^2/\text{s} / 162 \text{ SUS}$ (0 = casing empty)

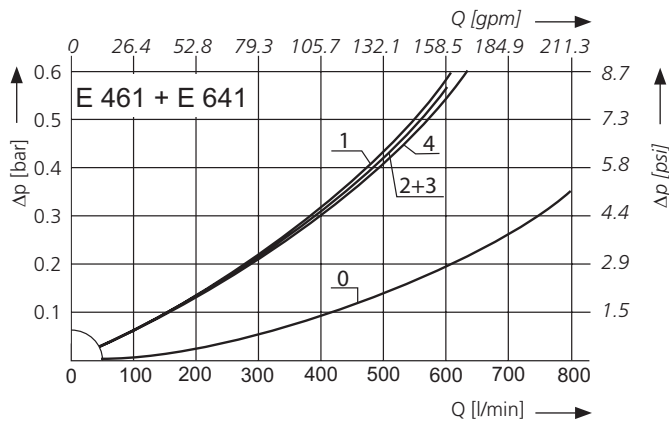

Pressure drop as a function of the **kinematic viscosity** at nominal flow

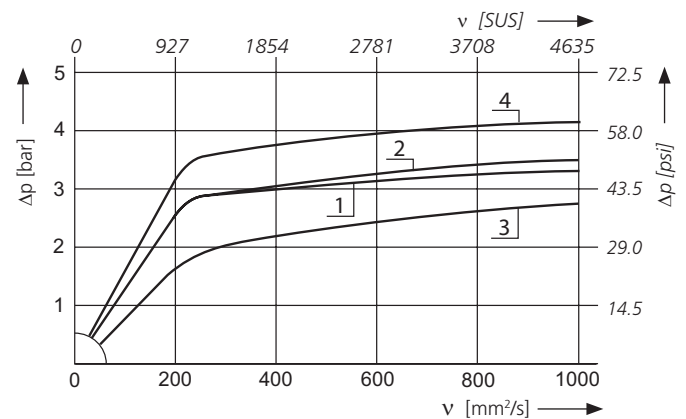

D4 Pressure drop as a function of the **flow volume** at $v = 35 \text{ mm}^2/\text{s} / 162 \text{ SUS}$ (0 = casing empty)

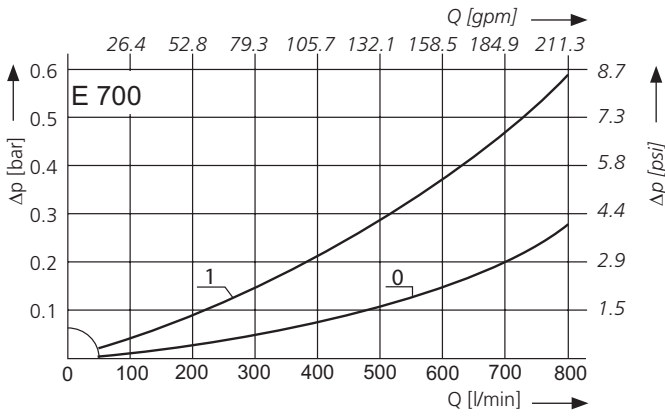

Pressure drop as a function of the **kinematic viscosity** at nominal flow

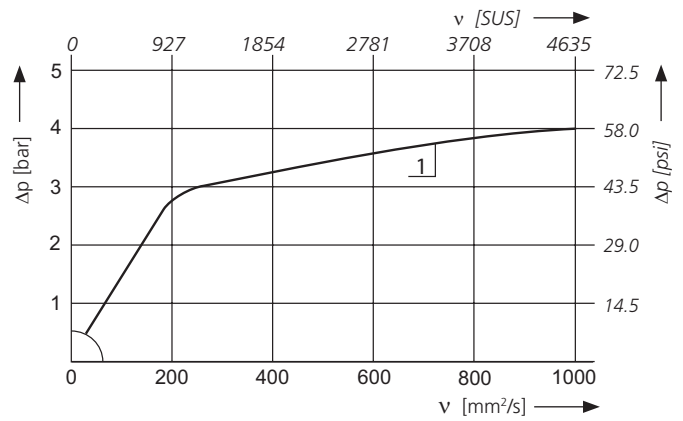

Filter fineness curves in Selection Chart, column 4

Dx Filtration ratio β as a function of particle size x obtained by the Multi-Pass-Test according to ISO 16889

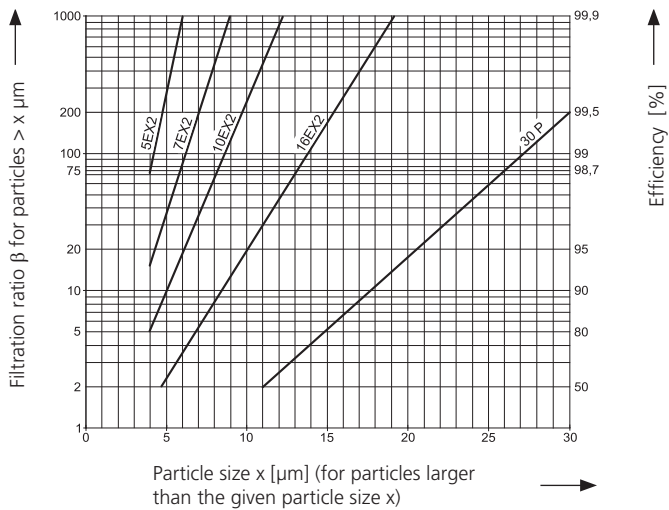

The abbreviations represent the following β -values resp. finenesses:

For EXAPOR®MAX 2 and Paper elements:

5EX2 =	$\beta_{5(c)} = 200$	EXAPOR®MAX 2
7EX2 =	$\beta_{7(c)} = 200$	EXAPOR®MAX 2
10EX2 =	$\beta_{10(c)} = 200$	EXAPOR®MAX 2
16EX2 =	$\beta_{16(c)} = 200$	EXAPOR®MAX 2
30P =	$\beta_{30(c)} = 200$	Paper

Based on the structure of the filter media of the 30P paper elements, deviations from the printed curves are quite probable.

For screen elements:

- 40S = screen material with mesh size 40 μm
- 60S = screen material with mesh size 60 μm
- 100S = screen material with mesh size 100 μm

Tolerances for mesh size according to DIN 4189.

For special applications, finenesses differing from these curves are also available by using special composed filter material.

Selection Charts

Part No.	Nominal flow rate		Pressure drop see diagram D1 /curve no.	Filter fineness see Diagr. Dx	Dirt-holding capacity	Connection A		Cracking pressure of by-pass	Symbol	Replacement filter element Part No.	Weight		Remarks
	l/min	gpm				g	bar				psi	kg	
1	2	3	4	5	6	7	8	9	10	11			
E 441-156¹	200	53	D1/1	10EX2	61	-	2.5	36	1	V2.1217-56	2.4	5.3	-
E 441-168¹	270	71	D1/2	16EX2	62	-	2.5	36	1	V2.1217-58	2.4	5.3	-
E 441-153	175	46	D1/3	30P	29	-	1.5	21	1	P2.1217-51 ²	2.4	5.3	-
E 451-156¹	375	99	D2/1	10EX2	130	-	2.5	36	1	V2.1234-26	4.1	9.0	-
E 451-168¹	480	127	D2/2	16EX2	124	-	2.5	36	1	V2.1234-28	4.1	9.0	-
E 451-153	350	92	D2/3	30P	63	-	1.5	21	1	P2.1234-41 ²	4.1	9.0	-
E 461-156¹	500	132	D3/1	10EX2	200	-	2.5	36	1	V2.1250-06	5.8	12.8	-
E 461-168¹	600	180	D3/2	16EX2	200	-	2.5	36	1	V2.1250-08	5.8	12.8	-
E 461-153	480	127	D3/3	30P	95	-	1.5	21	1	P2.1250-11 ²	5.8	12.8	-
E 641-76¹	680	180	D3/4	10EX2	250	-	3.0	43	1	V2.1260-46	7.5	16.5	-
E 700-156¹	800	211	D4/1	10EX2	300	-	2.5	36	1	V2.1460-26	12.4	27.3	-

¹ Preferred type, no minimum order quantity required

² Paper media supported with metal gauze

As clogging indicators either manometers or electrical pressure switches can be used. Filters can also be supplied with an outlet diffuser. Optional extension pipes adapt the filter length to various tank depths. For ordering of accessories please use the below mentioned codes.

Order example: The filter E 451-156 has to be supplied with an outlet diffuser and an extension pipe (EV) for 580 mm (22.83 inch) length.

Order description: E 451-156 / VD / EV 580

Part No. (Basic unit) _____

Options:

Two options are available

VD: Outlet diffuser, RV: Extension pipe _____

Extension pipes:

5 various lengths are available _____

E 441 / E 451 / E 461 / E 641:

EV = K + 87 (3.43 inch) / + 142 (5.59 inch) / + 202 (7.95 inch) / + 237 (9.33 inch) / + 362 (14.25 inch) (see sect. dimensions / measurements)

E 700: EV on request.

For the appropriate clogging indicators see catalog sheet 60.20.

Remarks:

- › The switching pressure of the electrical pressure switch has always to be lower than the cracking pressure of the by-pass valve (see Selection Chart, column 7).
- › Clogging indicators are optional and always delivered detached from the filter.
- › The filters listed in this chart are standard filters. Other designs are available on request.

Dimensions

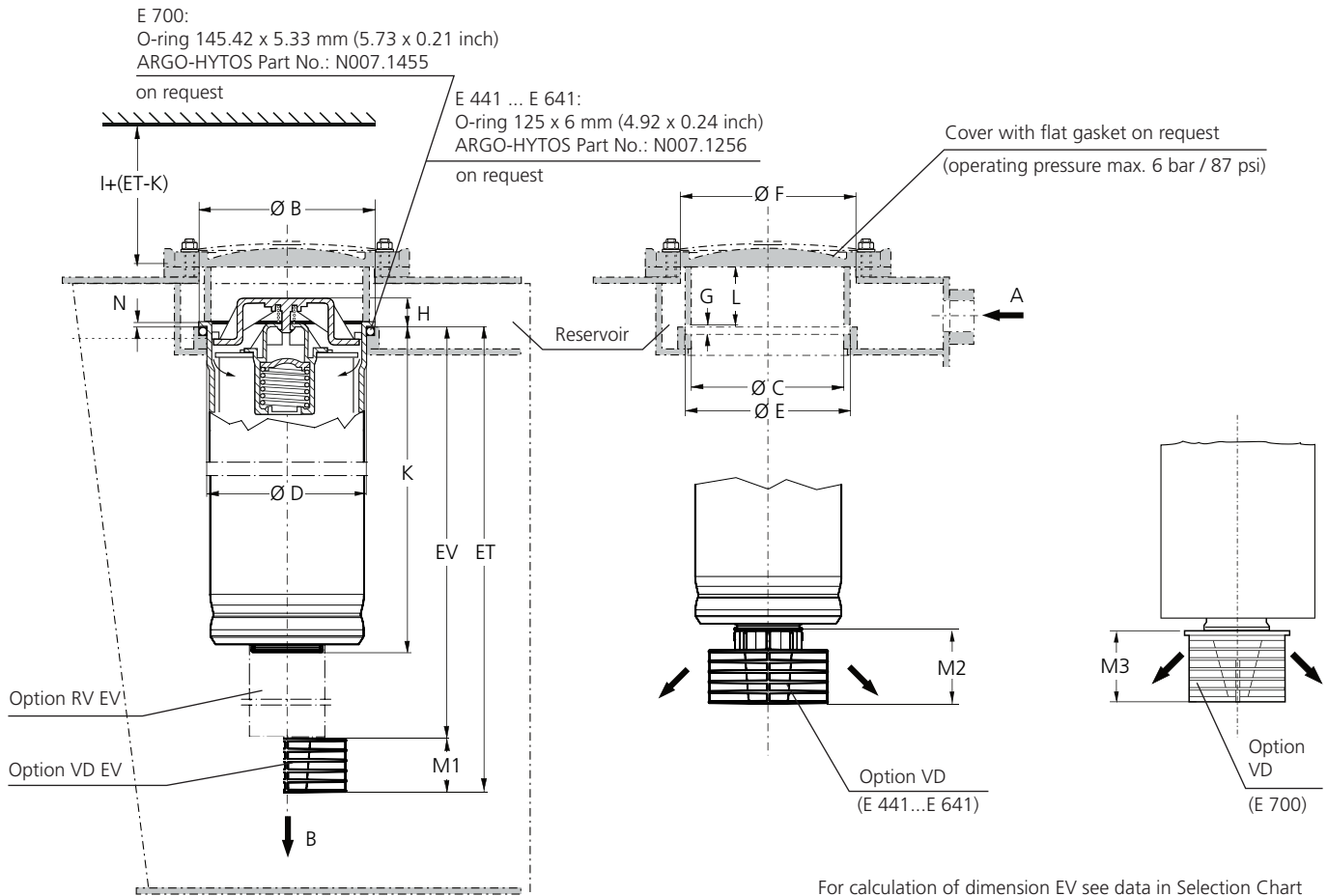

Measurements in mm

Type	A	B	C	D	E	F	G	H	I	K	L	M ₁	M ₂	M ₃	N
E 441	-	142 ^{+2/-0,5}	132	131	145	>145	6.5	26	250	211	48	47.5	62	-	1.5
E 451	-	142 ^{+2/-0,5}	132	131	145	>145	6.5	26	410	378	48	47.5	62	-	1.5
E 461	-	142 ^{+2/-0,5}	132	131	145	>145	6.5	26	580	546	48	47.5	62	-	1.5
E 641	-	142 ^{+2/-0,5}	132	131	145	>145	6.5	26	680	644	48	47.5	62	-	1.5
E 700	-	167 ⁺²	155	155	170	>170	6.5	27	700	651	82	-	-	58	1.5

Measurements in inch

Type	A	B	C	D	E	F	G	H	I	K	L	M ₁	M ₂	M ₃	N
E 441	-	5.59 ^{+0.08}	5.20	5.16	5.71	>5.71	0.26	1.02	9.84	8.31	1.89	1.87	2.44	-	0.06
E 451	-	5.59 ^{+0.08}	5.20	5.16	5.71	>5.71	0.26	1.02	16.14	14.88	1.89	1.87	2.44	-	0.06
E 461	-	5.59 ^{+0.08}	5.20	5.16	5.71	>5.71	0.26	1.02	22.83	21.50	1.89	1.87	2.44	-	0.06
E 641	-	5.59 ^{+0.08}	5.20	5.16	5.71	>5.71	0.26	1.02	26.77	25.35	1.89	1.87	2.44	-	0.06
E 700	-	6.57 ^{+0.08}	6.10	6.10	6.69	>6.69	0.26	1.06	27.56	25.63	3.23	-	-	2.28	0.06

Symbol

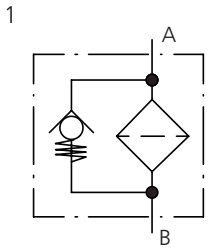

Spare Parts

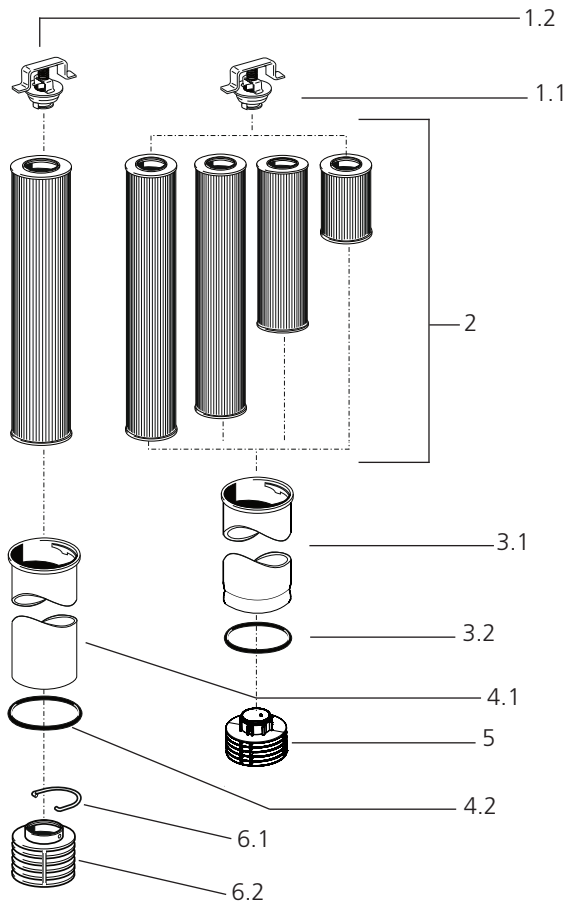

Pos.	Designation	Part No.
1.1	By-pass (1.5 bar / 22 psi)	E 440.1500
1.1	By-pass (2.5 bar / 36 psi)	E 460.1520
1.1	By-pass (3.0 bar / 43 psi)	E 640.1510
1.2	By-pass (2.5 bar / 36 psi) for E 700	E 703.1510
2	Replacement filter elements	s. Chart / col. 9
3.1	Filter bowl E 441 ¹	E 441.1900
3.1	Filter bowl E 451 ¹	E 451.1900
3.1	Filter bowl E 461 ¹	E 461.1900
3.1	Filter bowl E 641 ¹	E 641.1900
3.2	O-ring ² 125 x 6 mm 4.92 x 0.24 inch	N007.1256
4.1	Filter bowl E 700	E 700.1900
4.2	O-ring ² 145.42 x 5.33 mm (for E 700) 5.73 x 0.21 inch (for E 700)	N007.1455
5	Diffusor	E 441.0701
6.1	Clip (version VD for E 700)	N 026.0311
6.2	Diffusor (version VD for E 700)	E 703.0701

¹ Please indicate options (VD, VDEV and RVEV respectively)

² Not included in basic equipment

The functions of the complete filters as well as the outstanding features of the filter elements assured by ARGO-HYTOS can only be guaranteed if original ARGO-HYTOS spare parts are used.

Quality Assurance

Quality management according to DIN EN ISO 9001

To ensure constant quality in production and operation, ARGO-HYTOS filter elements undergo strict controls and tests according to the following ISO standards:

ISO 2941	Verification of collapse / burst pressure rating
ISO 2942	Verification of fabrication integrity (Bubble Point Test)
ISO 2943	Verification of material compatibility with fluids
ISO 3968	Evaluation of pressure drop versus flow characteristics
ISO 16889	Multi-Pass-Test (evaluation of filter fineness and dirt-holding capacity)
ISO 23181	Determination of resistance to flow fatigue using high viscosity fluid

Various quality controls during the production process guarantee the leakfree function and solidity of our filters.

Illustrations may sometimes differ from the original. ARGO-HYTOS is not responsible for any unintentional mistake in this specification sheet.